



LITHIUM IRON PHOSPHATE

Giv-Bat 9.5 Installation Manual

GENERATION 2 | Giv-Bat 9.5
GIV-BAT-9.5-G2

SPECIFICATIONS



BIGGER AND BETTER Increased storage and efficiency

The 9.5kWh battery pack sits alongside our AC Coupled or Hybrid Inverter so that you can store energy from the grid or excess generation.

Utilising lithium iron phosphate, our batteries are extremely safe and can be installed in a wide range of locations. Our battery warranty means you can use your battery as much as you need for 12 years and still be covered.

SPECIFICATION

Dimensions

800H x 242D x 480W (mm)

Weight

110Kg

Operating Voltage Range

45V - 58V DC

Nominal Voltage

51.2V DC

Current

80A

Warranty

12 years

Usable Capacity

9.5kWh / 186Ah

Operating Temperature

-10°C - 55°C

Depth of Discharge

100%

BOX CONTENTS

Item	Item Name	Qty
A	Battery Module	1
B	Wall Mounting Bracket	6
C	Fixing Kit	2
D	Waterproof Blanking Plug	2

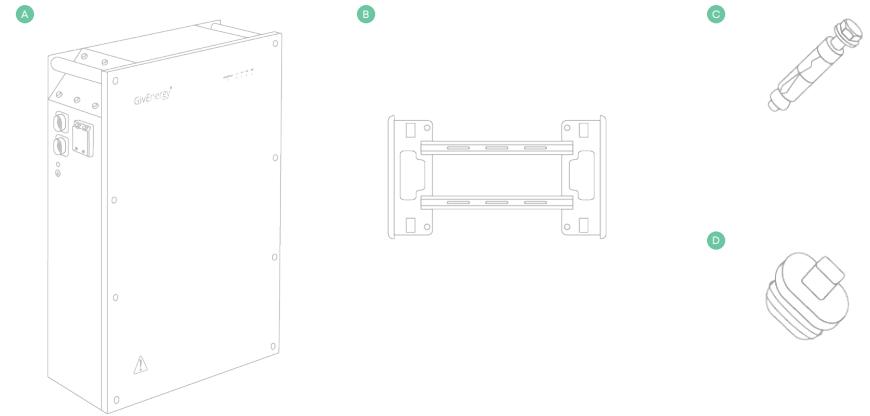

Introduction

All information contained in this booklet refers to the assembly, installation, commissioning, and maintenance of Generation 2 batteries. Please retain this manual for future reference.

Legal Disclaimer: This document is the property of GivEnergy, reproduction is prohibited.

Installation Requirements

Installation of all GivEnergy equipment must be carried out by a **GivEnergy Approved Installer**. Please ensure that there is sufficient space and ventilation around the battery before installation.

Unit Information

The Generation 2 batteries are designed to work with a GivEnergy AC Coupled or Hybrid Inverter. The batteries work with renewable generation or import from the grid at off-peak times when prices are lower, and discharge during busier periods when prices are more expensive.

Storing the Battery

The units must be stored in their original packaging at temperatures between -30°C - 60°C. Please note that between -10°C - 0°C there may be reduced performance in charging and discharging.

Do not stack more than 4 units on top of each other.

Packaging Contents

When unpacking, please check the following:

- ✔ There are no missing accessories from the packaging list
- ✔ The model and specification of the battery's nameplate match the order specifications

If any damaged or missing parts are found, please contact GivEnergy on **01377 252 874** or email **support@givenergy.co.uk** immediately. Returns must be provided in original or equivalent packaging. The cardboard packaging is recyclable.

Item	Item Name	Function
A	ON/OFF Switch	System Switch
B	STATUS	Status Indicators
C	Power Terminal	Power Connectors
D	DC MCB Breaker	Battery Isolator
E	Dip Switches	Dip Switch
F	Earthing Point	Earth Bonding



DC MCB / Dip Switches

BATTERY CABLES

Two Types of Cables Exist for Connection to Gen 2 Batteries

Lug to plug battery cable



Plug to plug battery cable



IMPORTANT

All Generation 2 battery cables need to be purchased separately.

SAFETY AND INSTALLATION

Safety Instructions

Extra care and attention must be taken when installing and maintaining any GivEnergy equipment. The system is capable of retaining a high voltage, even when disconnected.

- If you suspect something is wrong with the battery, contact GivEnergy on **01377 252 874** or email **support@givenergy.co.uk**
- If any damaged or missing parts are found, please contact GivEnergy on **01377 252 874** or email **support@givenergy.co.uk** immediately. Returns must be provided in original or equivalent packaging. The cardboard packaging is recyclable.

Installation Instructions

- All electrical installations must be carried out by a qualified and registered electrician and in accordance with the local Wiring Regulations and other relevant safety legislation
- Ensure batteries are always fixed to the wall using the mounting bracket, even when the weight of the product is on the floor
- All GivEnergy equipment must be installed by a **GivEnergy Approved Installer**
- Externally mounted batteries must always be wall mounted above the frost-line or a minimum of 50mm
- An earth bond must be installed between all batteries and inverters
- Do not remove the front cover unless instructed by the GivEnergy support team



Do not use the battery if there are any deformities, such as bulging or leakages



Do not puncture the battery



Do not throw the battery or use forceful impact



Do not attempt to repair the battery yourself (please call your Approved Installer)



The battery must be installed vertically, never install horizontally, avoid tilting the unit

STEP-BY-STEP INSTALLATION

1. Place the wall mounting bracket horizontally onto the wall and mark the position of the bracket holes.

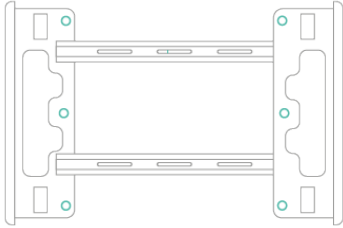

2. Drill 6 holes at the marked positions, at least 75mm deep. Fix the mounting bracket to the wall using 6 expansion bolts.

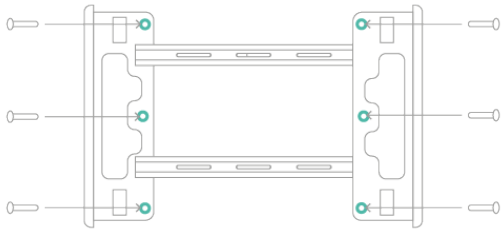

3. Mount the battery onto the mounting bracket.

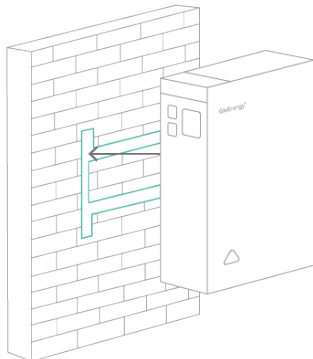

STEP-BY-STEP INSTALLATION

For Generation 1 Inverters Only

- 4A. Connect output A to the inverter using a lug to plug cable. If not connecting to additional battery packs, apply the blanking plug to output B.

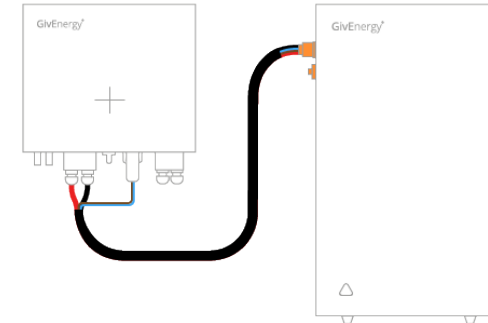

For Generation 2 Inverters Only

- 4B. If multiple Generation 2 batteries are installed, connect output B of the first battery to output A on the additional battery packs using a plug to plug cable. There must be no more than 5 batteries installed.

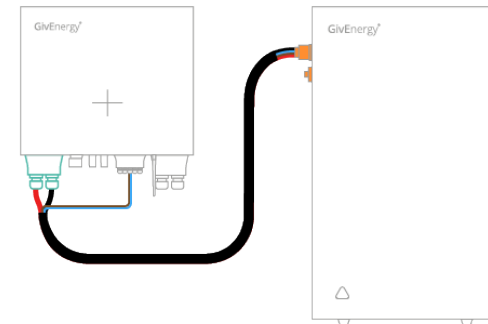

STEP-BY-STEP INSTALLATION

For Generation 3 Inverters Only

- 4A.** If connecting to Generation 3 inverter, use a plug to plug cable from output A of the Generation 2 battery to the connectors within the Generation 3 inverter.

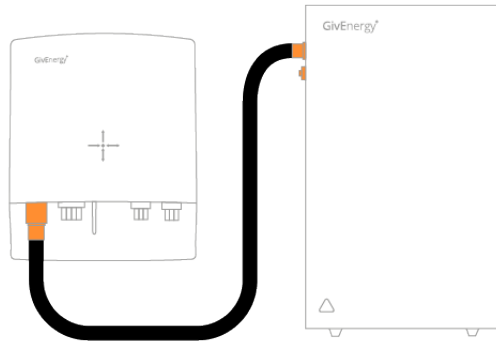

For Installing Additional Batteries

- 4D.** If connecting a Generation 1 battery to a Generation 2 battery use a plug to lug cable and connect from output B in your Generation 2 battery into the comms connection within the Generation 1 battery, and set your dip switches as per instructed within the GivEnergy installation guide.

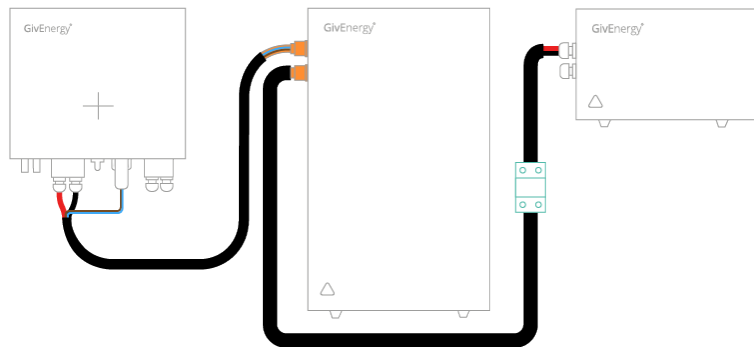

STEP-BY-STEP INSTALLATION

- 4E.** If connecting a Generation 2 battery to a Generation 2 battery use a plug to plug cable and connect from output B in your master battery into output A of your slave Generation 2 battery, and set your dip switches as per step 5 (below).

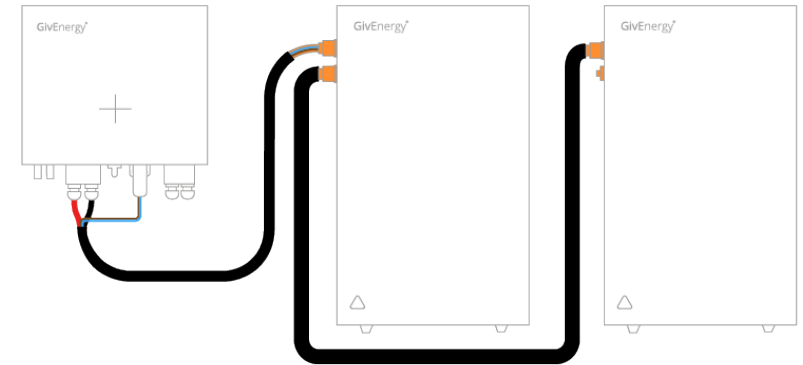

- 5.** Set up the dip switches on the circuit breaker, as shown overleaf.

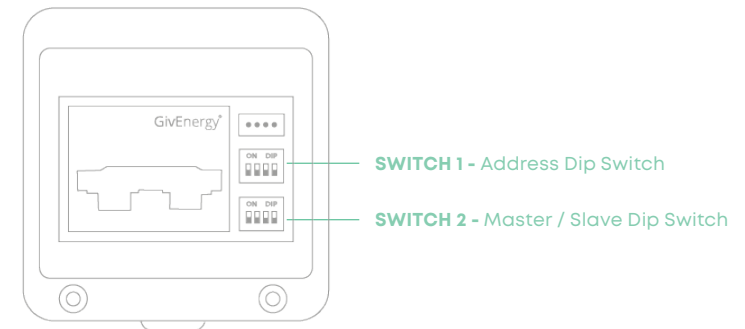





- 6.** Push the 'On/Off' button on the right hand side of the battery, the LEDs will light up.
- 7.** Commission the battery on the online portal and ensure the battery is operating normally.



DIP SWITCHES AND STATUS INDICATORS

Dip Switches

Switch 1

Battery	ID	Description
Master		0, 0, 0, 0
Slave 1		1, 0, 0, 0
Slave 2		0, 1, 0, 0
Slave 3		0, 0, 1, 0
Slave 4		0, 0, 0, 1

Switch 2

Battery	ID	Description
Master		0, 0, 0, 0
Slave 1		1, 0, 0, 0

Status Indicators

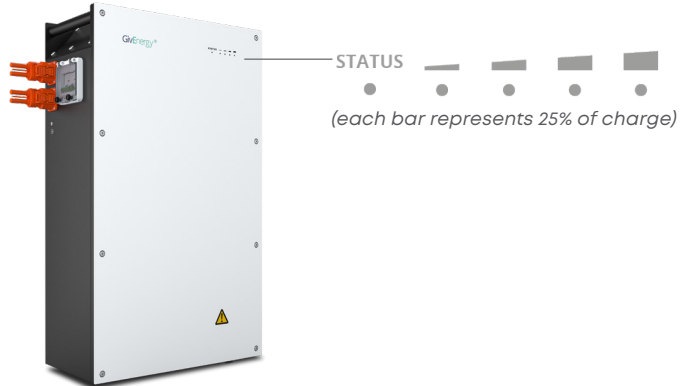

What does the STATUS light mean?

Green	Healthy, good state of charge (SOC)
Amber/Green, flashing	Firmware update
Green, flashing	Lower state of charge, outside of normal operating voltage
Red, flashing	Very low state of charge
Red	Fault. Logged in system. If the light is red, call GivEnergy for remote diagnostics.

MANUFACTURER WARRANTIES

GivEnergy is the main supplier and manufacturer of the product. GivEnergy warrants that your product is (a) of acceptable quality and (b) does not have any latent defects.

- ✔ If you suspect something is wrong with the battery, contact GivEnergy on **01377 252 874** or email **support@givenergy.co.uk**
- ✔ If any damaged or missing parts are found, please contact GivEnergy on **01377 252 874** or email **support@givenergy.co.uk** immediately. Returns must be provided in original or equivalent packaging. The cardboard packaging is recyclable.

Products Covered



GivEnergy

Phone	UK +44 01377 252 874 NL +31 85 208 6376
Email	UK support@givenergy.co.uk NL support@givenergy.com SA support.sa@givenergy.com AU martin.cobb@givenergy.com
Website	www.givenergy.com